

ЭКО ШПОН



Snow Art



Snow Veralinga

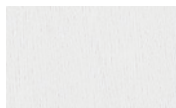

Virgin



Milk Oak



Bianco Veralinga



Nordik Oak

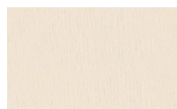

Ivory

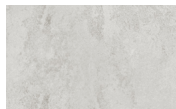

Grey Art



Cappuccino Veralinga



Organik Oak



Anegri Veralinga



Golden Reef



Original Oak



Grey Veralinga



Graphite Art



Brown Oak



Thermo Oak



Dark Oak

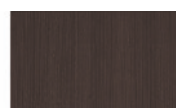

Wenge Veralinga

ПОД ОКРАСКУ

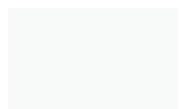

Prime

ВАРИАНТЫ ИСПОЛНЕНИЯ

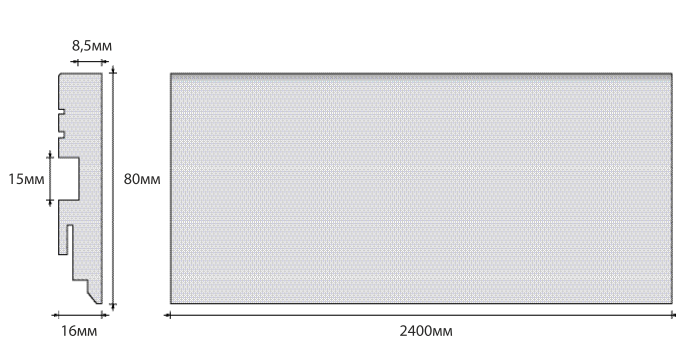

ТИП-0

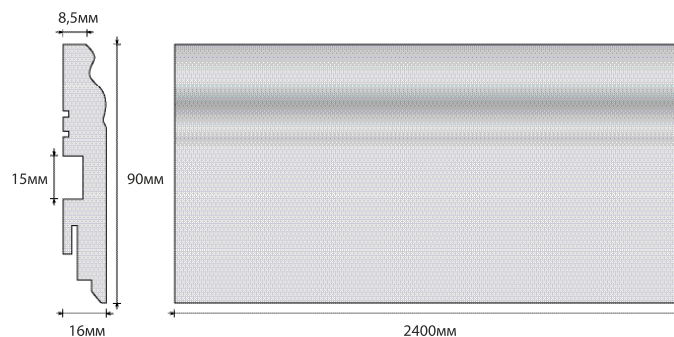

ТИП-2

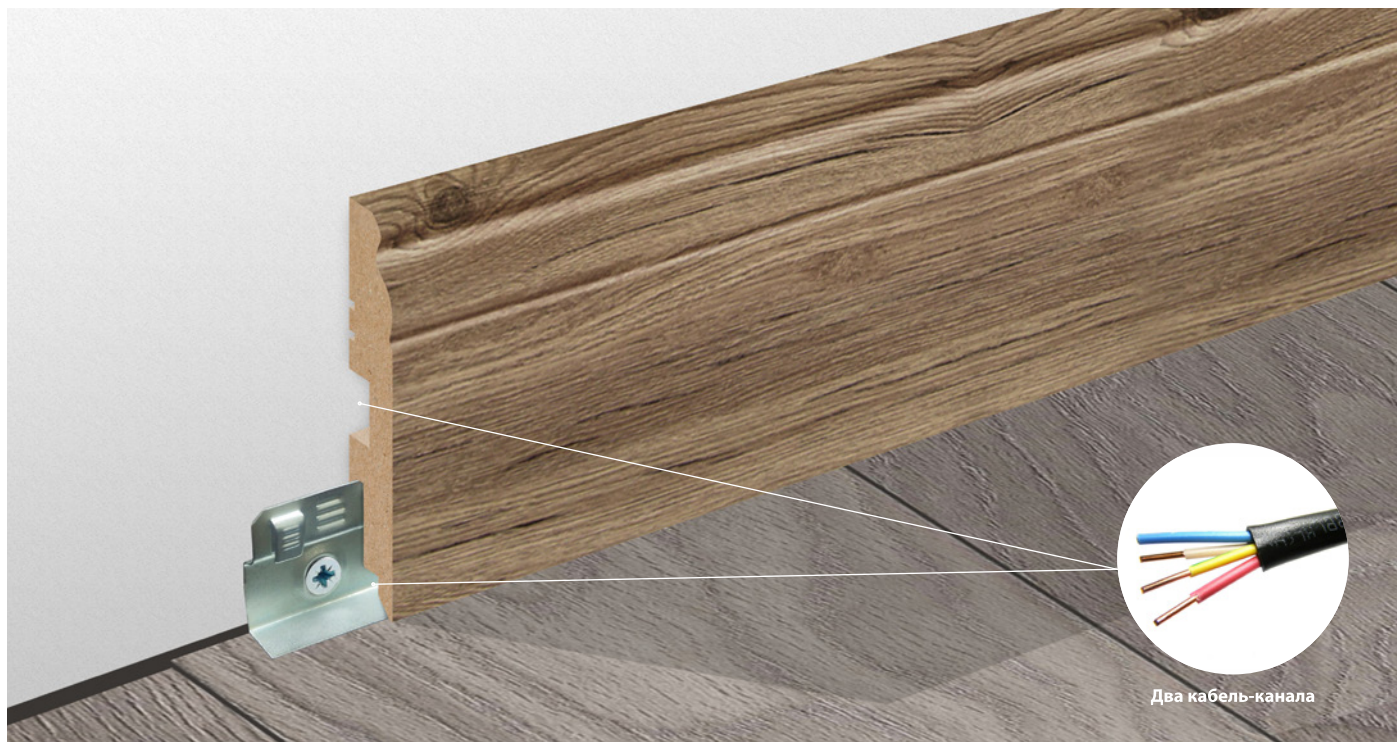

Два кабель-канала

ПЛИНТУС НАПОЛЬНЫЙ ТИП-2
Original Oak

ВАРИАНТЫ КРЕПЛЕНИЯ



Монтажная клипса обеспечивает возможность легкого демонтажа и обратной установки плинтуса. Крепится к стене на расстоянии от 30 до 40 см.

ИЛИ



Универсальный монтажный клей.
Рекомендуем: Tytan Classic Fix.

СХЕМА ЗАРЕЗКИ И СТЫКОВКИ УГЛОВ

ВАРИАНТ ЗАРЕЗКИ №1

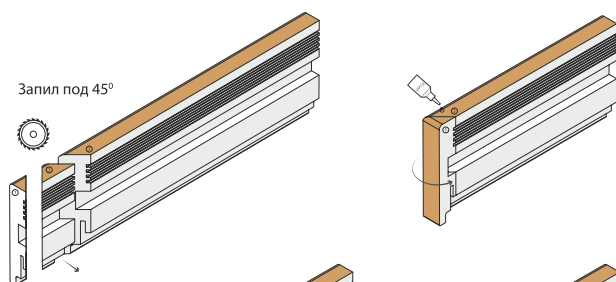

Запил под 45°

ВАРИАНТ ЗАРЕЗКИ №2

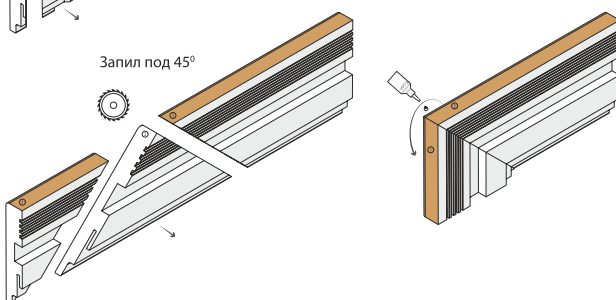

Запил под 45°

ВНЕШНИЙ УГОЛ

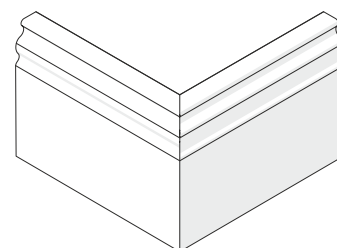

ВНУТРЕННИЙ УГОЛ

